

MODEL 45-01773 14 CU. FT. FARM/YARD CART

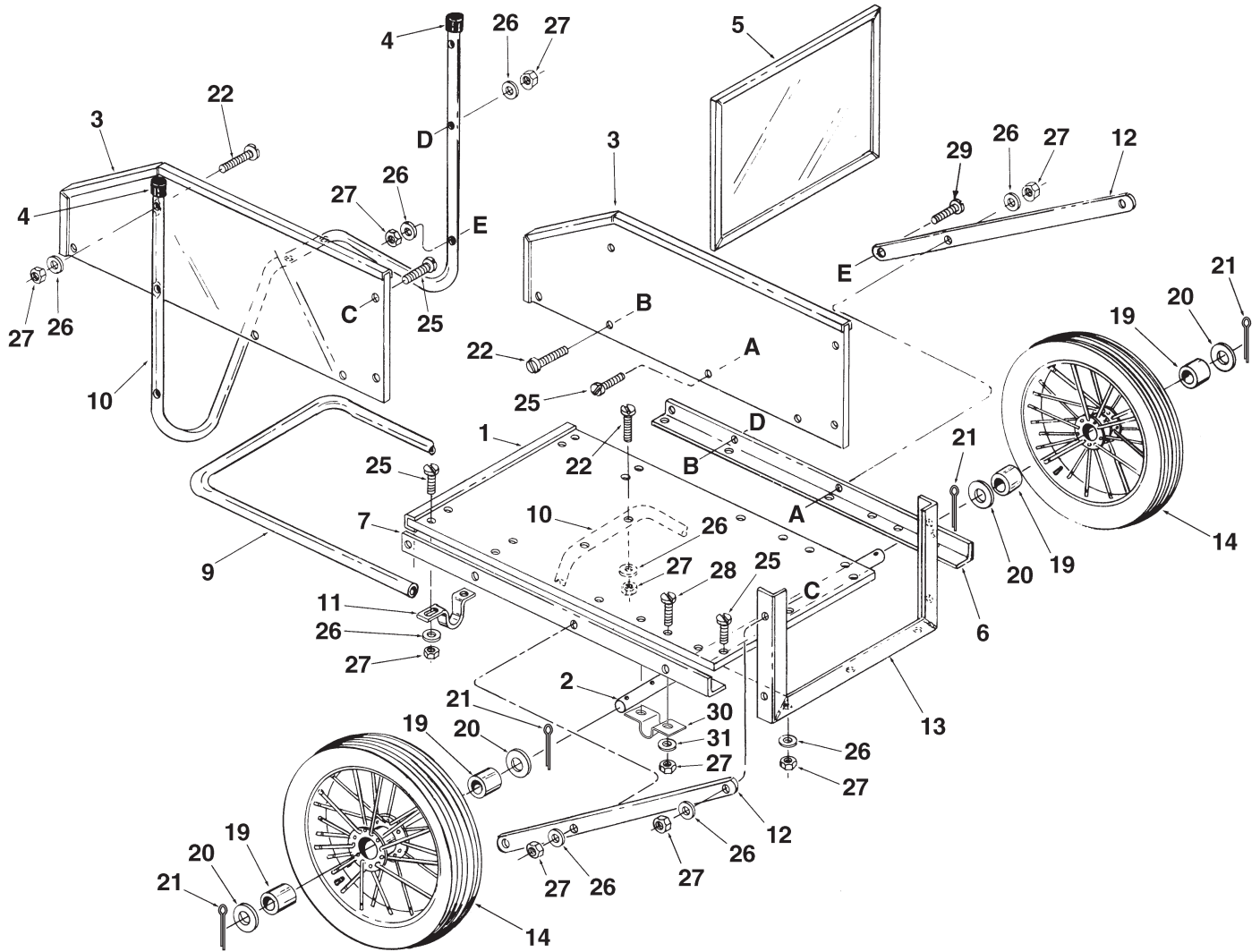

REF. NO.	PART NO.	QTY.	DESCRIPTION	REF. NO.	PART NO.	QTY.	DESCRIPTION
1	49123	1	Bottom Panel	19	49301	4	Ball Bearing, $\Phi 20$
2	25244	1	Axle	20	49295	4	Large Flat Washer
3	49322	2	Side Panel	21	43010	4	Cotter Pin
4	44481	2	Tube Caps	22	49296	6	M6x50 Screw
5	49124	1	Front Panel	25	49297	21	M6x25 Screw
6	24887	1	Side Angle, L.H.	26	49298	33	$\Phi 6$ Flat Washer
7	24888	1	Side Angle, R.H.	27	49299	37	M6 Hex Nut
9	49125	1	Handle Tube	28	49302	8	M6x30 Screw
10	49126	1	Leg Tube	29	49324	2	M6x40 Screw
11	44033	4	Clamp, Tube	30	23917	2	Axle Clamp
12	23882	2	Support Strap	31	49303	4	$\Phi 6$ Lock Washer
13	64886	1	Front Angle Assembly		49579	1	Owner's Manual
14	49323	2	Wheel				

SpeedPart the fastest way to purchase parts www.speedpart.com